

# OS PRINCIPAIS SÍMBOLOS DA ELÉTRICA INDUSTRIAL

*Versão 1.1*



**SALA DA  
ELÉTRICA**



# BOTOEIRA

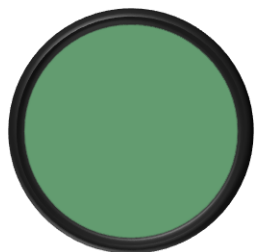

**SÍMBOLO  
LITERAL**

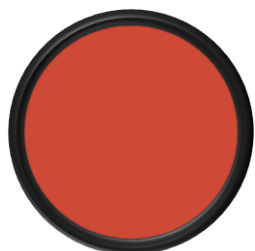

**S**

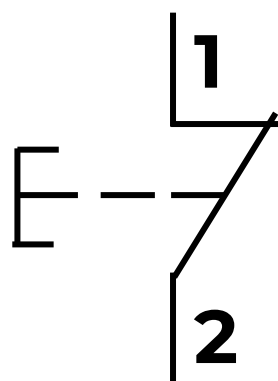
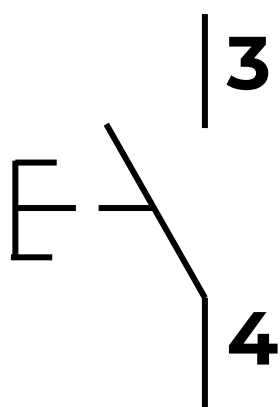
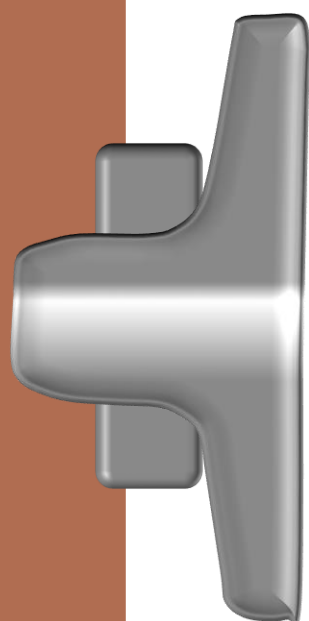

**SÍMBOLO  
GRÁFICO**

# SINALEIRO

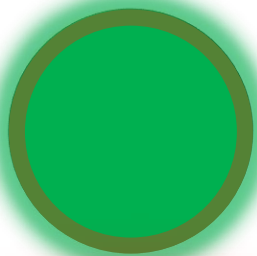

**SÍMBOLO  
LITERAL**



**H**

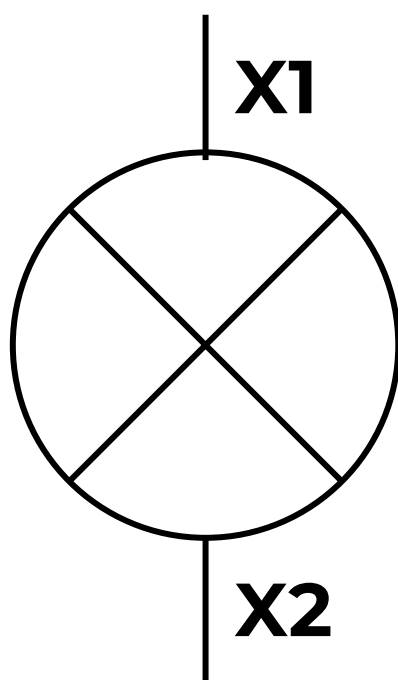
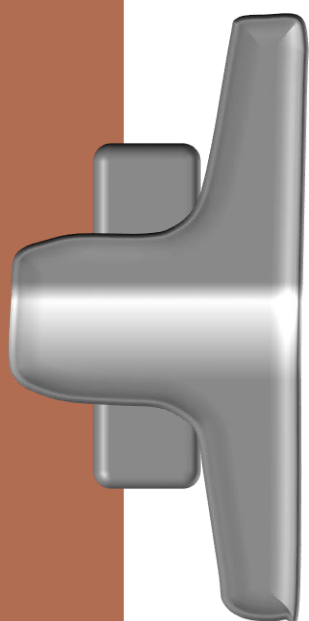

**SÍMBOLO  
GRÁFICO**

# CONTATOR



**SÍMBOLO  
LITERAL**

**K**

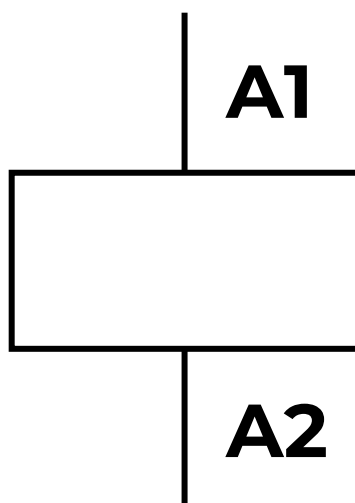
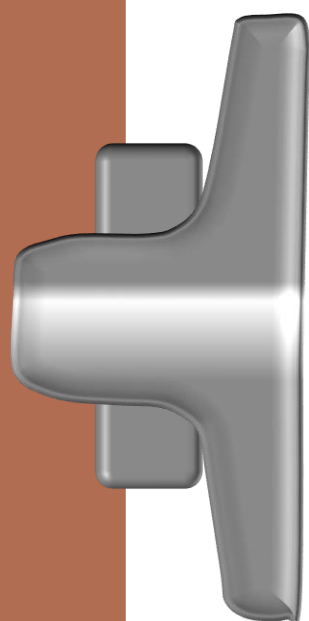

**SÍMBOLO  
GRÁFICO**

# CONTATOS CONTATOR

**SÍMBOLO  
LITERAL**

**K**

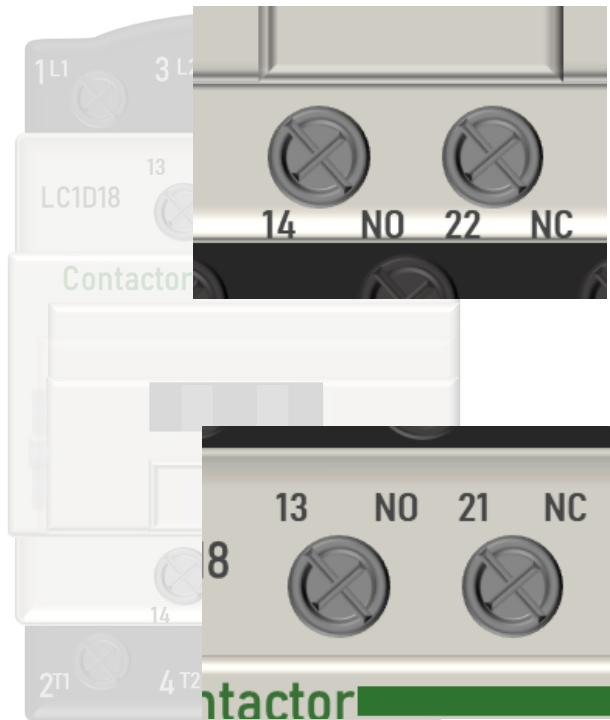

**SÍMBOLO  
GRÁFICO**

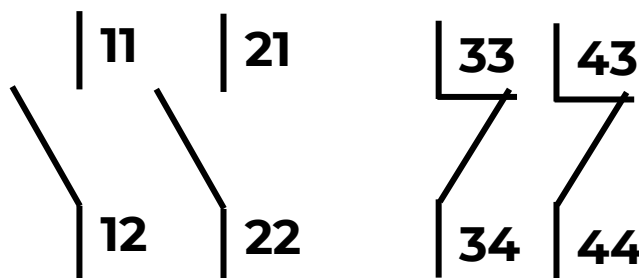
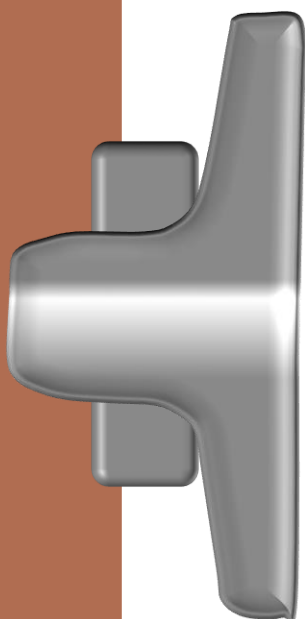

# FUSÍVEIS



**SÍMBOLO  
LITERAL**

**F**

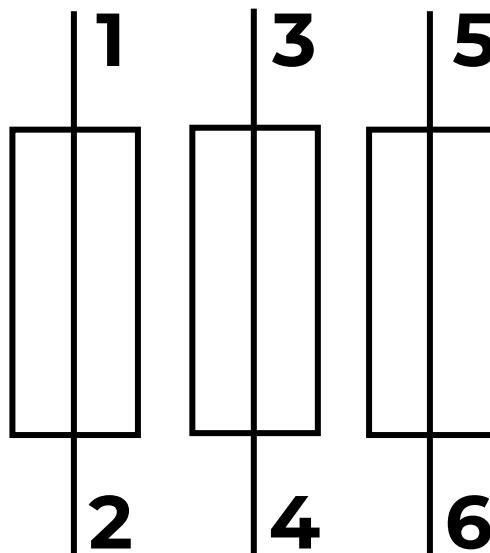
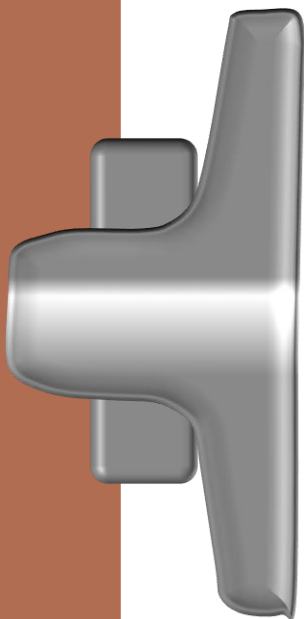

**SÍMBOLO  
GRÁFICO**

# DISJUNTOR MOTOR



**SÍMBOLO  
LITERAL**

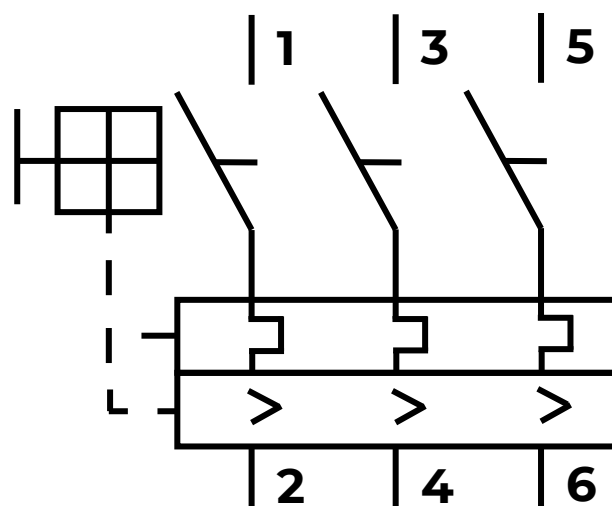
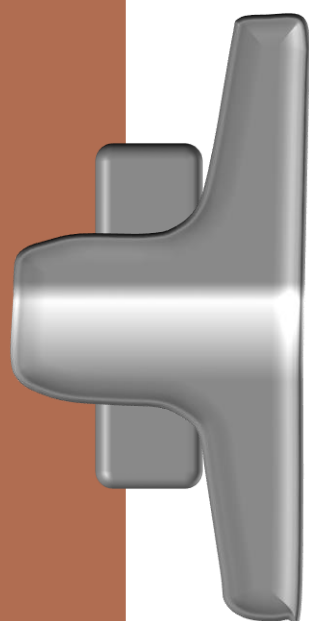

**SÍMBOLO  
GRÁFICO**



# DISJUNTOR BIPOLAR

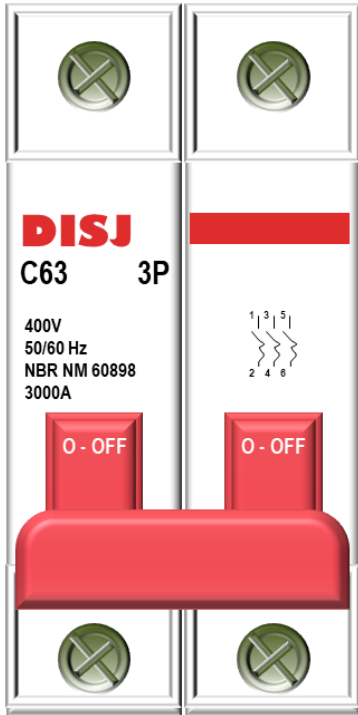

**SÍMBOLO  
LITERAL**

**F**

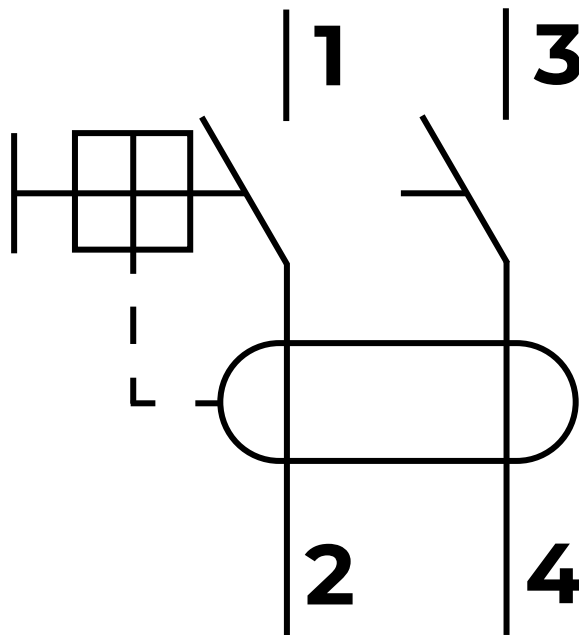
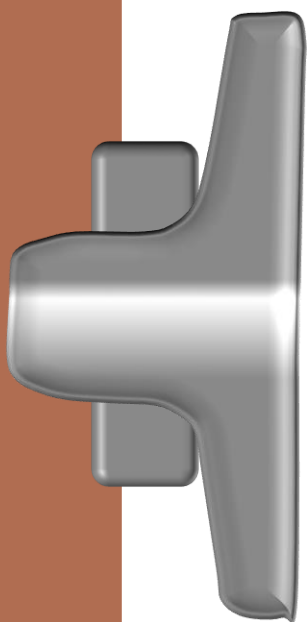

**SÍMBOLO  
GRÁFICO**

# DISJUNTOR TRIPOLAR

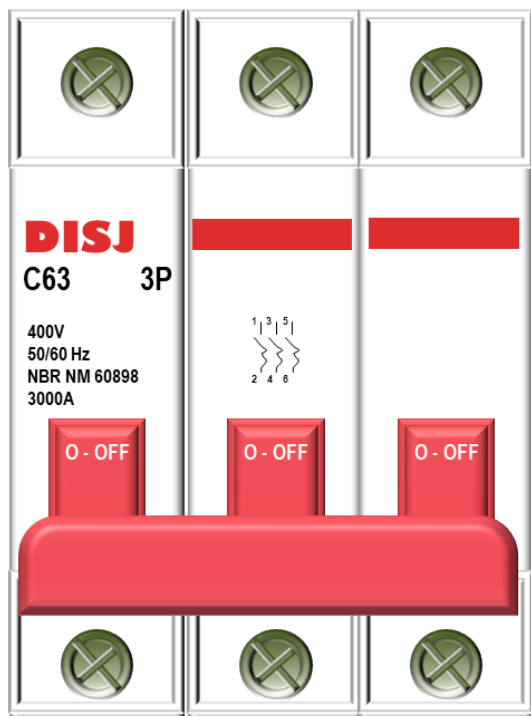

**SÍMBOLO  
LITERAL**

**F**

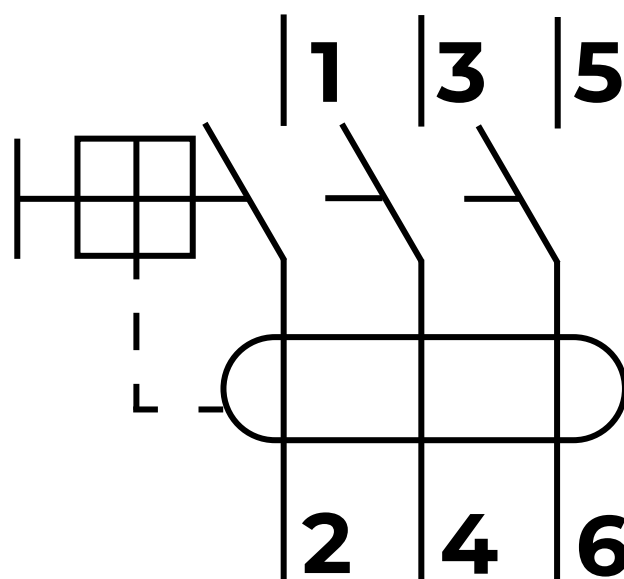
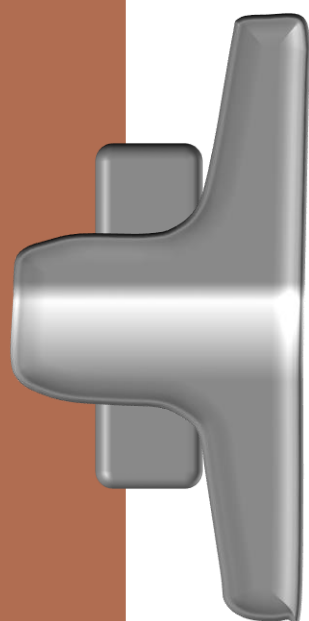

**SÍMBOLO  
GRÁFICO**



# MOTOR TRIFÁSICO

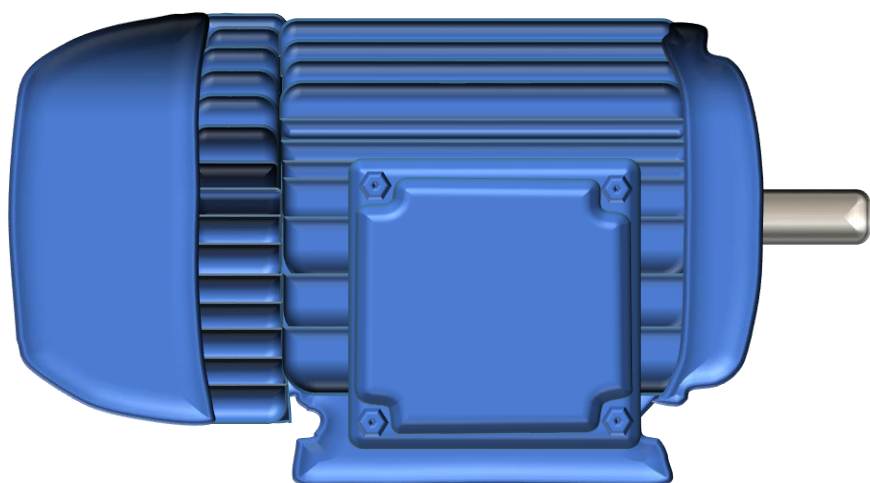

**SÍMBOLO  
LITERAL**

**M**

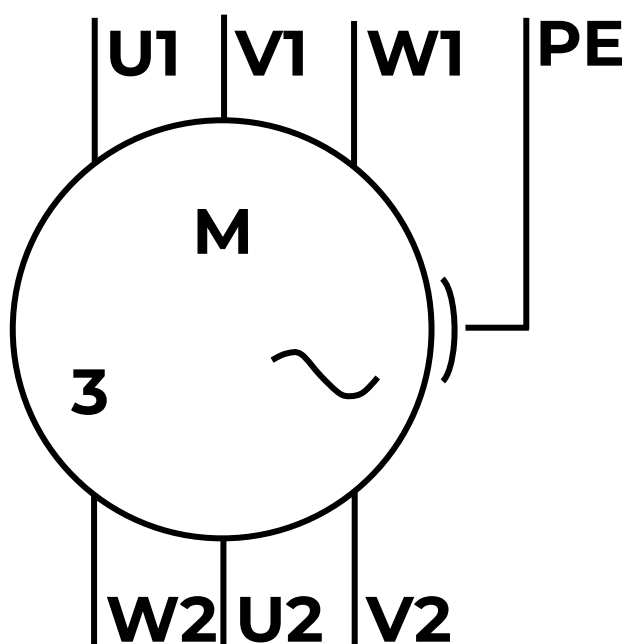
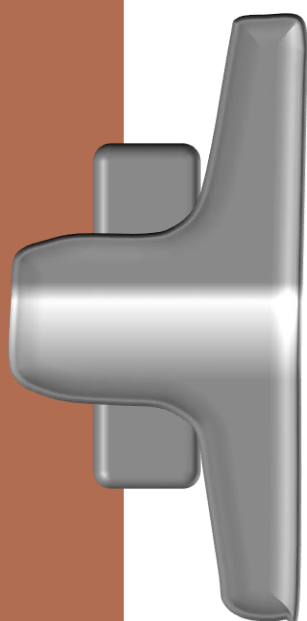

**SÍMBOLO  
GRÁFICO**

# RELÉ TÉRMICO

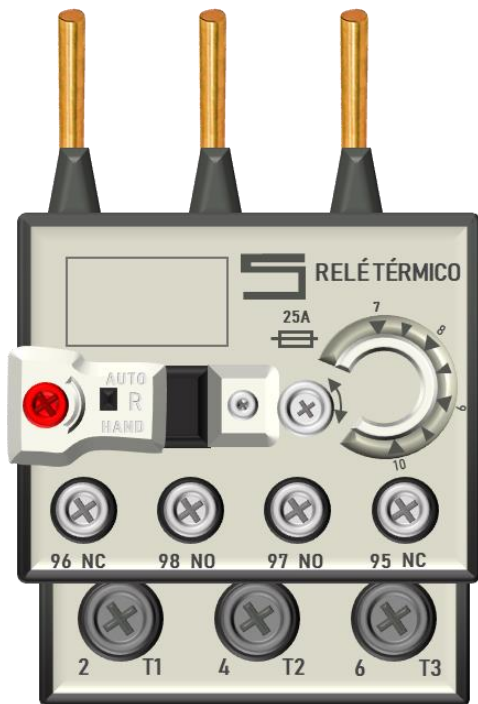

**SÍMBOLO  
LITERAL**

**F**

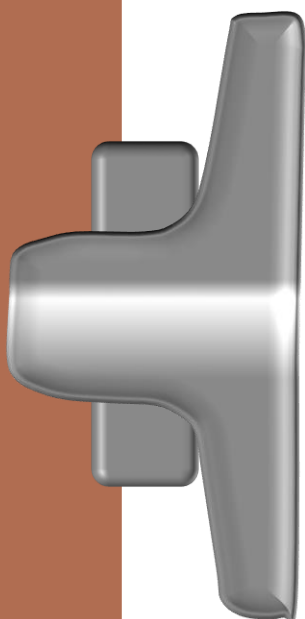

**SÍMBOLO  
GRÁFICO**

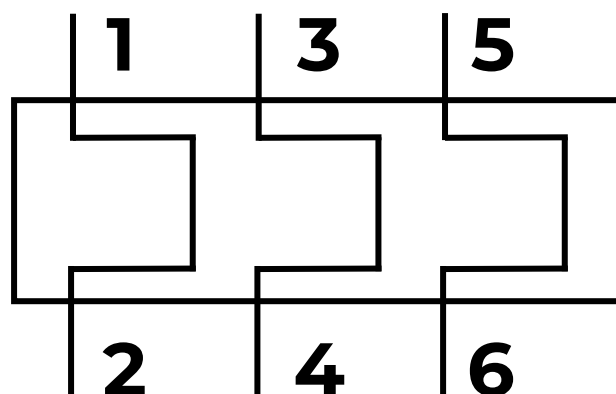

# RELÉ TÉRMICO - CONTATOS

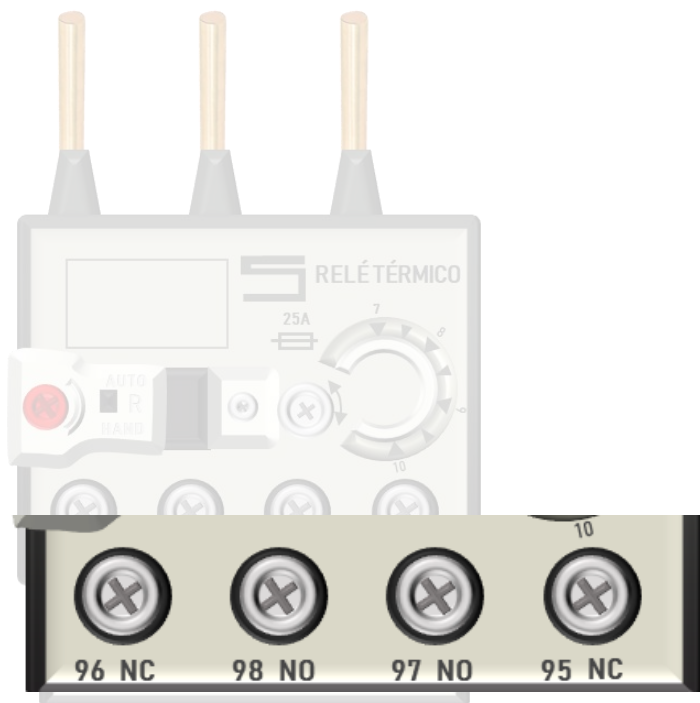

**SÍMBOLO  
LITERAL**

**F**

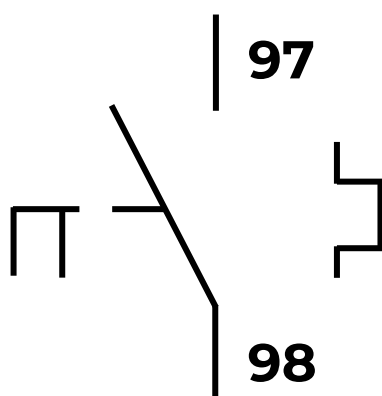
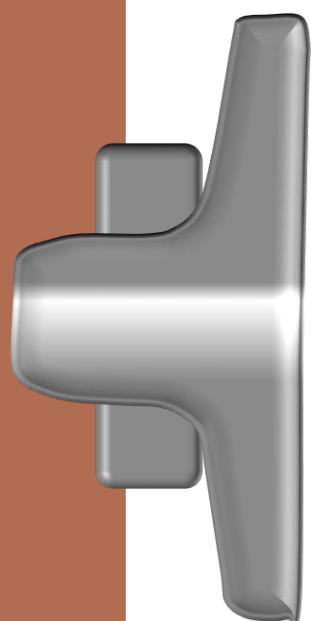

**SÍMBOLO  
GRÁFICO**

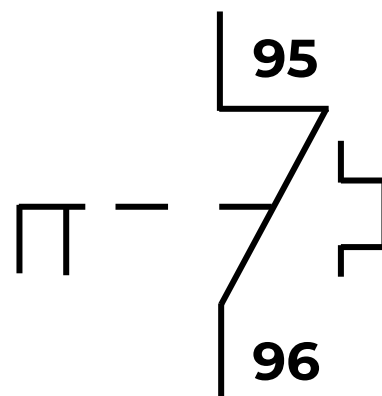

# TEMPORIZADOR



**SÍMBOLO  
LITERAL**

**D**

**SÍMBOLO  
GRÁFICO**

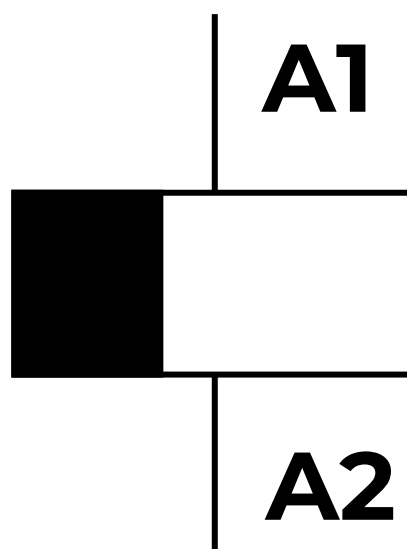
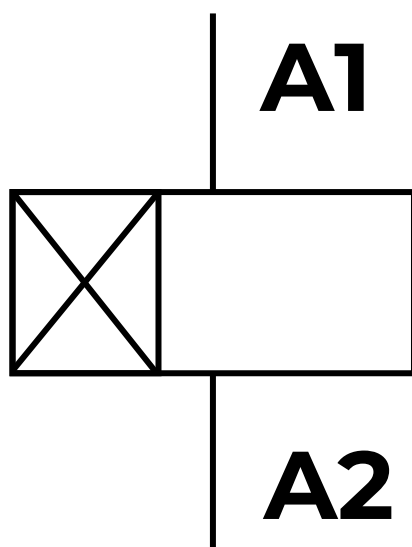
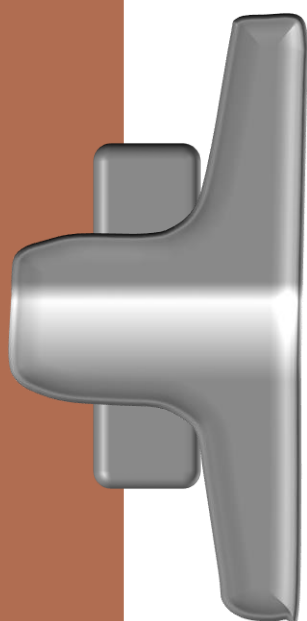

# CONTATO DO TEMPORIZADOR

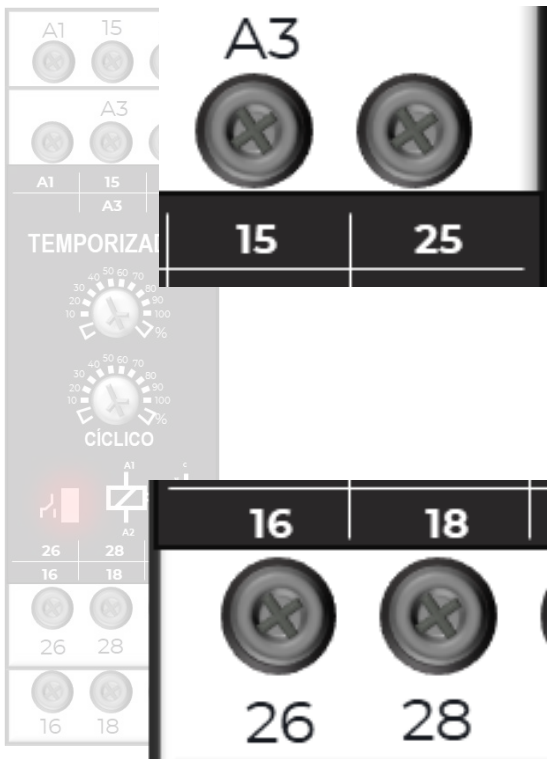

**SÍMBOLO  
LITERAL**

**D**

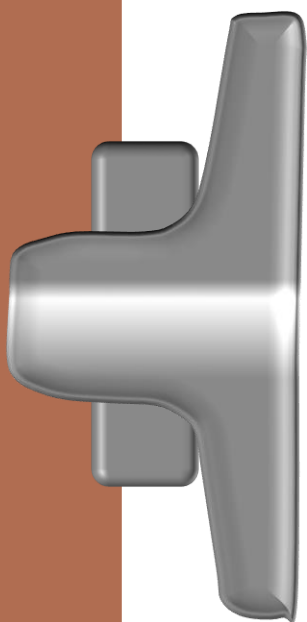

**SÍMBOLO  
GRÁFICO**

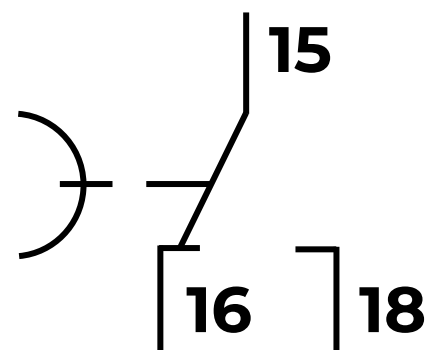
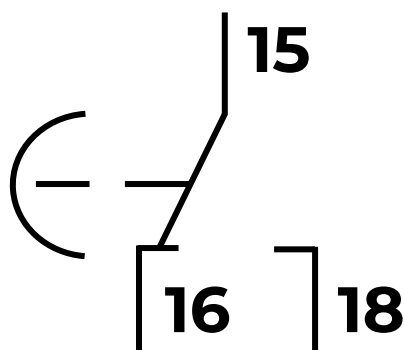



# AUTO TRANSFORMADOR



**SÍMBOLO  
LITERAL**

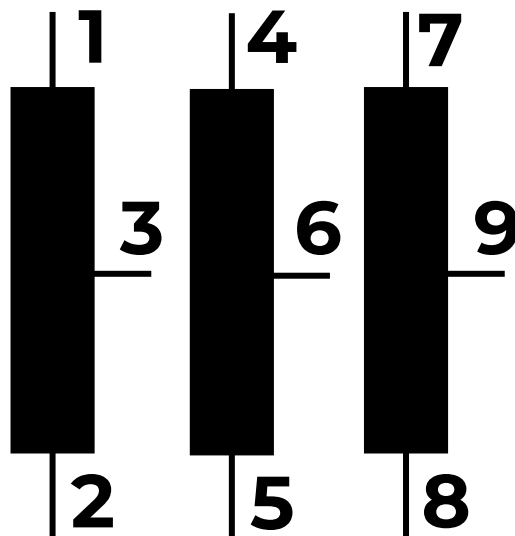
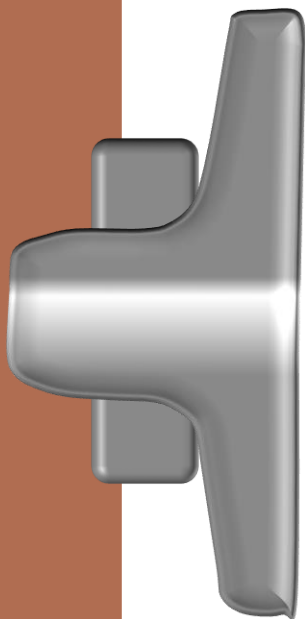

**SÍMBOLO  
GRÁFICO**

# TRANSFORMADOR MONO

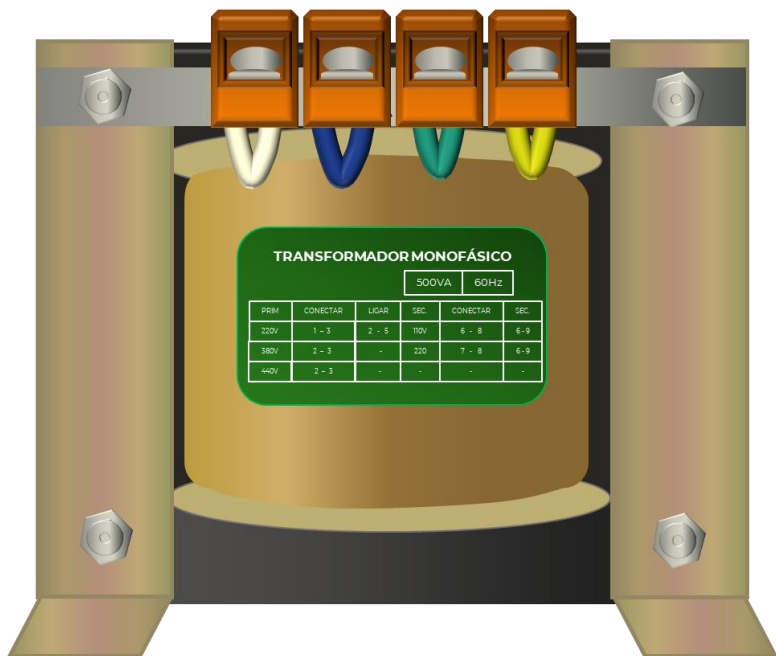

**SÍMBOLO  
LITERAL**

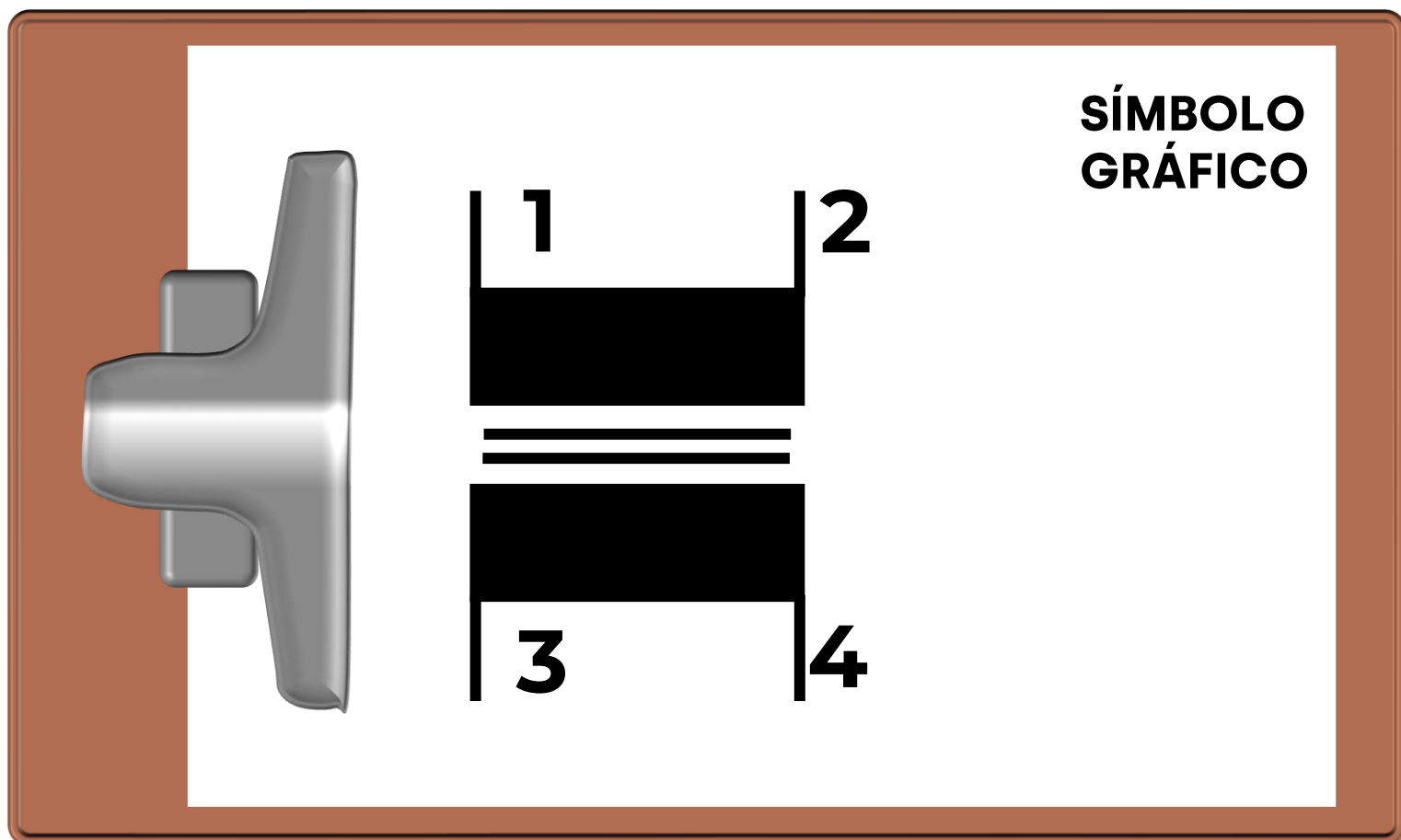

**SÍMBOLO  
GRÁFICO**

# TRANSFORMADOR TRI

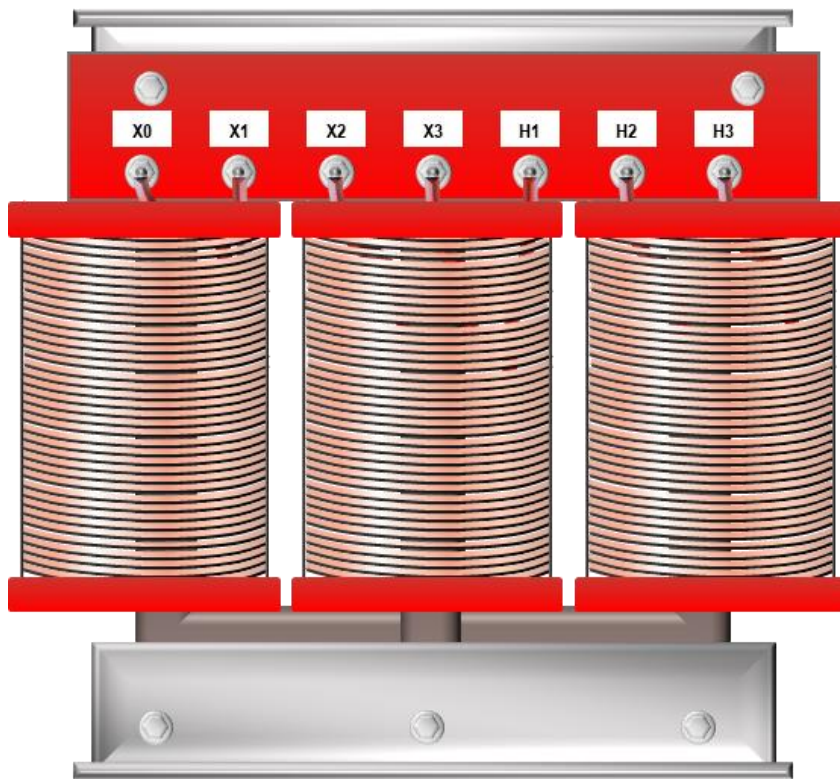

**SÍMBOLO  
LITERAL**

**T**

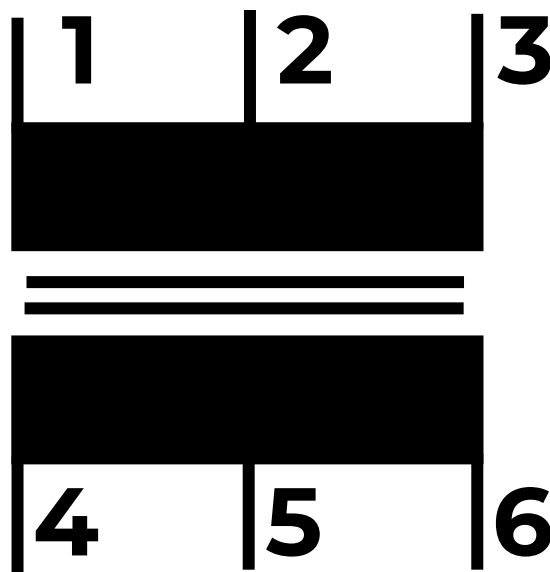
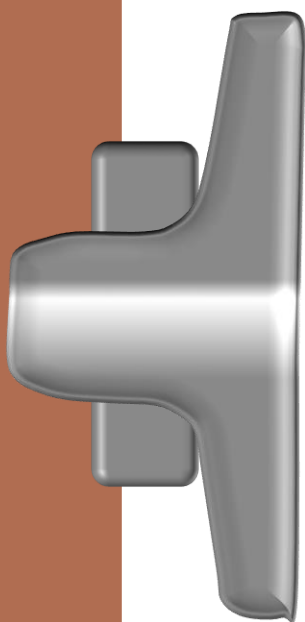

**SÍMBOLO  
GRÁFICO**

# SOFT STARTER



**SÍMBOLO  
LITERAL**

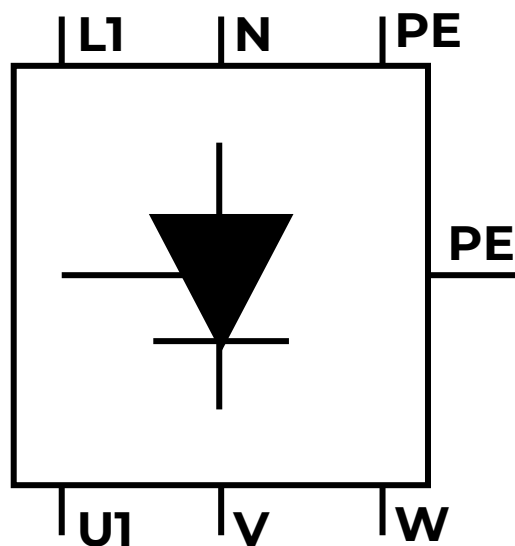
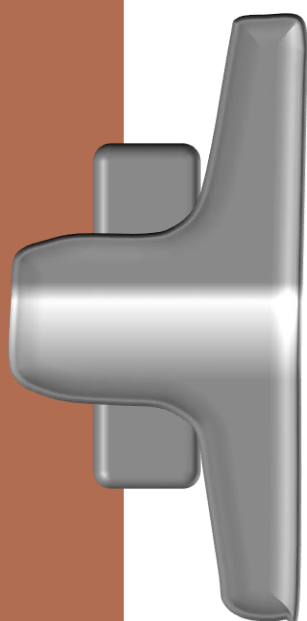

**SÍMBOLO  
GRÁFICO**

# INVERSOR DE FREQUÊNCIA



**SÍMBOLO  
LITERAL**

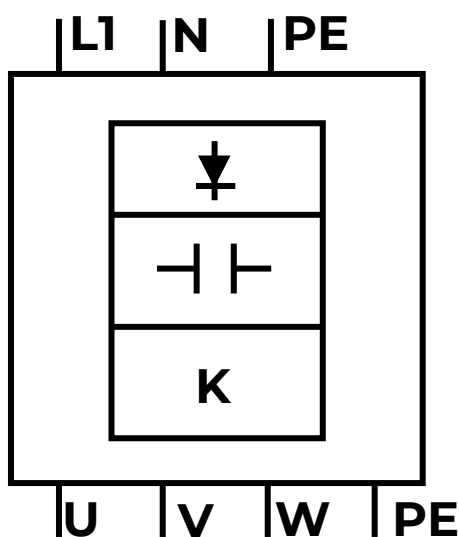
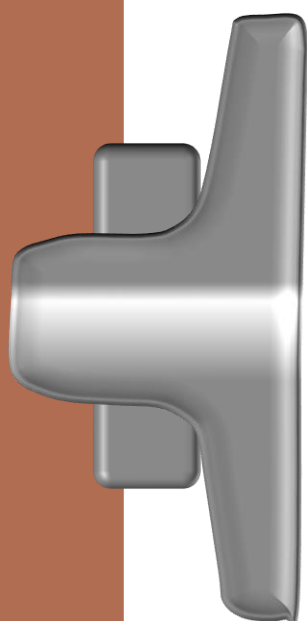

**SÍMBOLO  
GRÁFICO**

# SENSOR CAPACITIVO

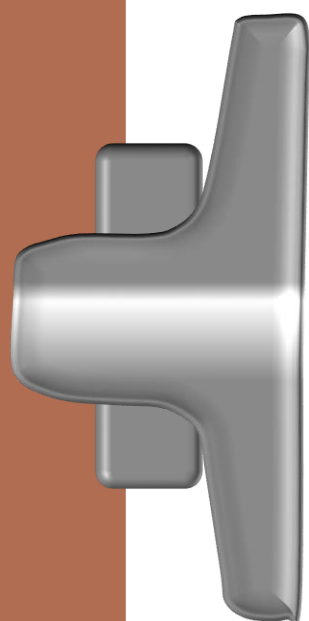
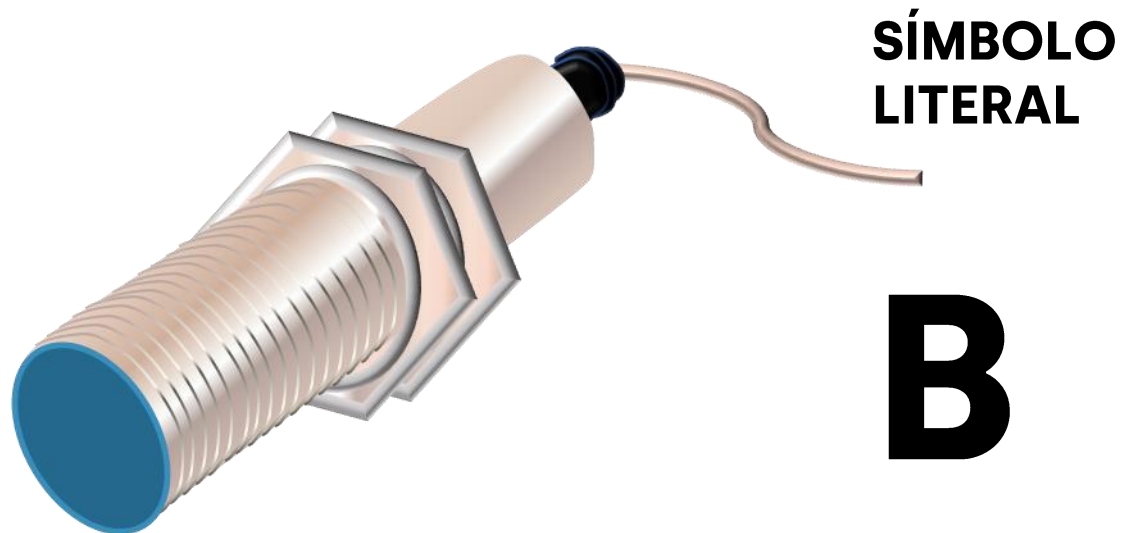

**SÍMBOLO GRÁFICO**

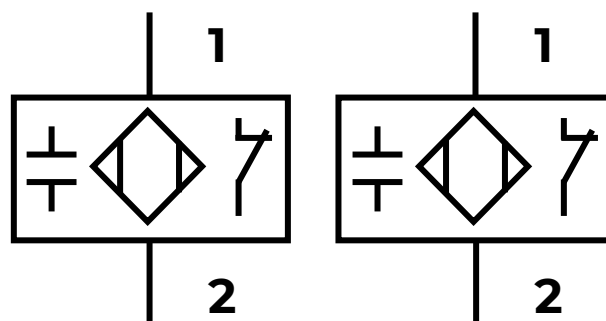

# SENSOR FOTOELÉTRICO

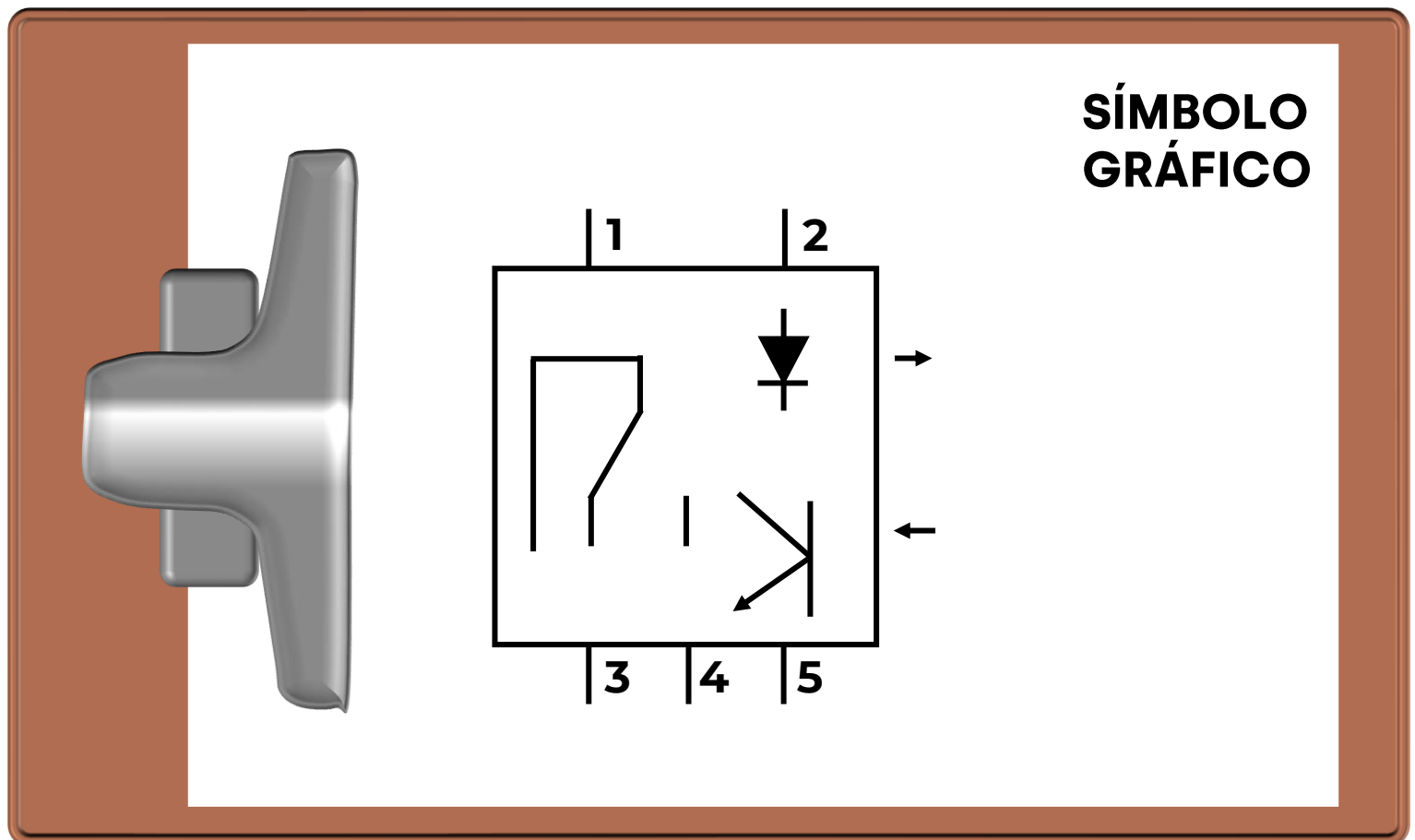
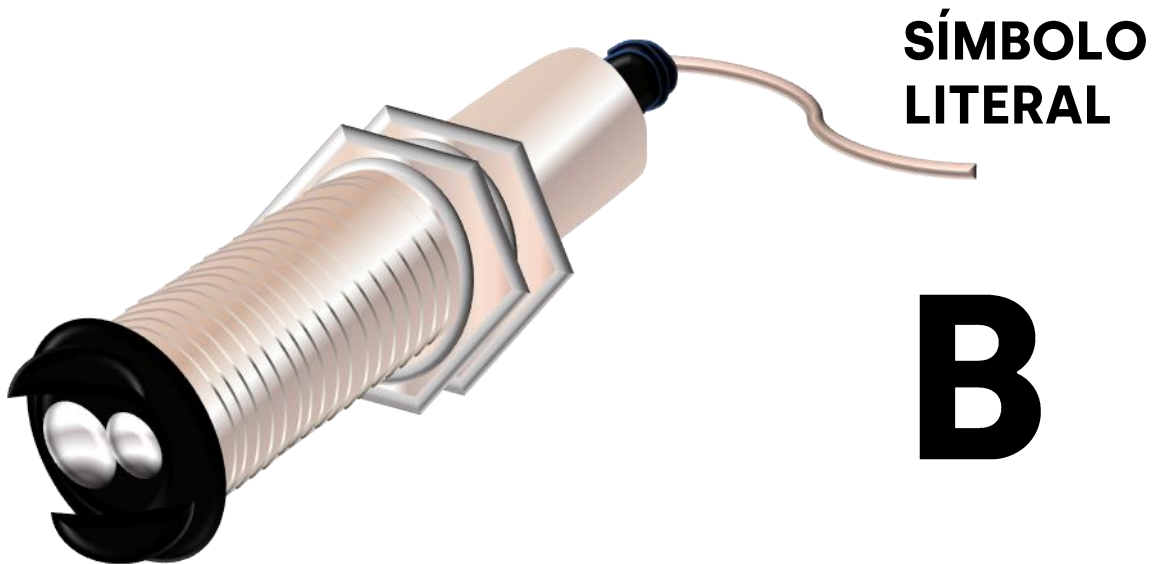

# SENSOR INDUTIVO

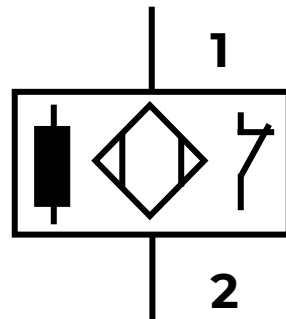
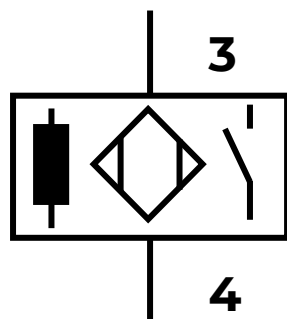
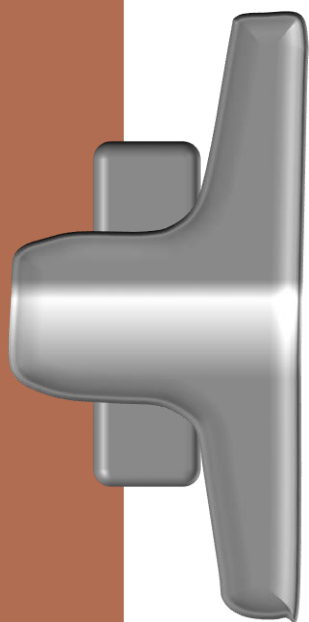
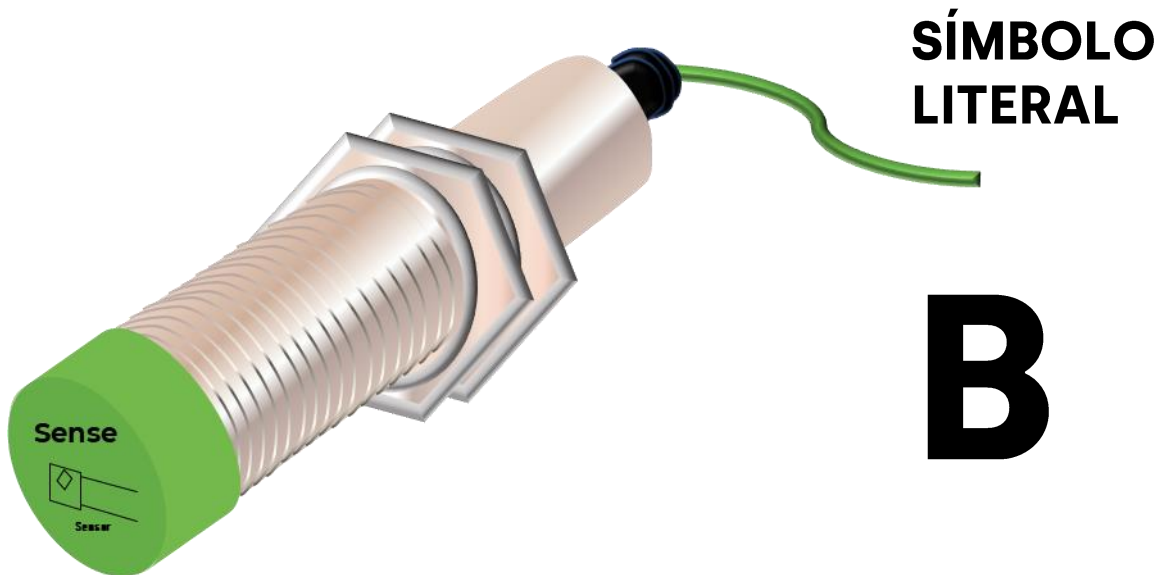

SÍMBOLO GRÁFICO



# SENSOR MAGNÉTICO

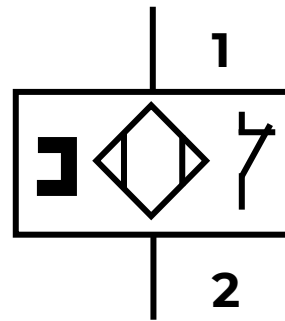
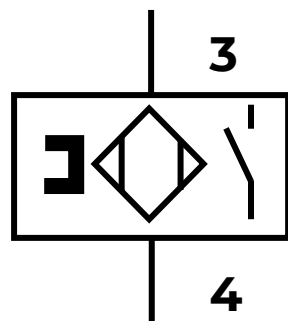
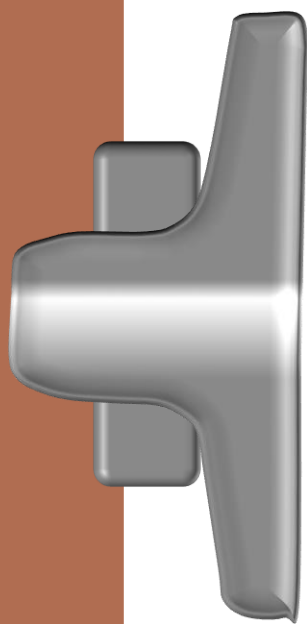
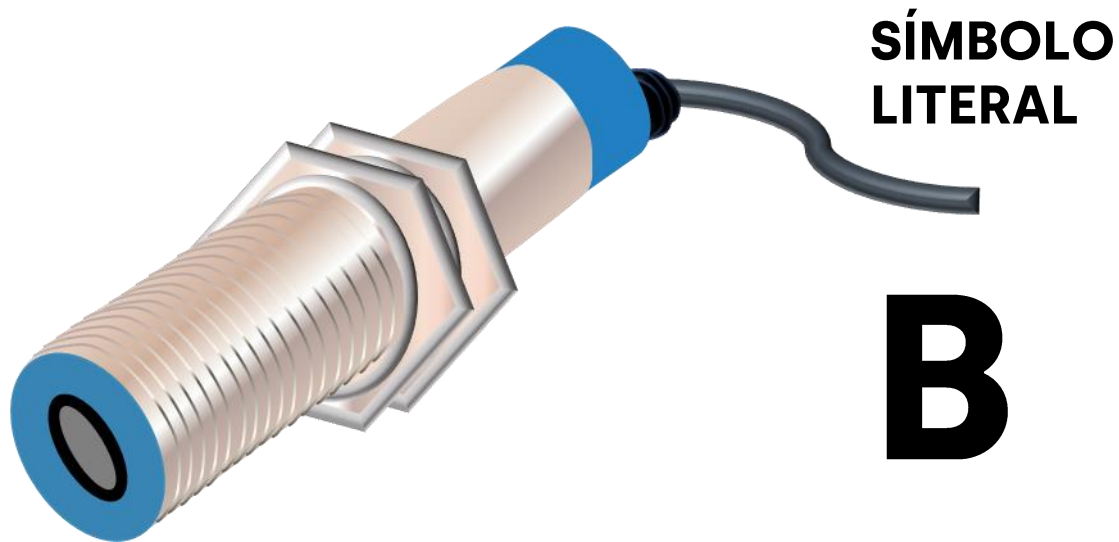

**SÍMBOLO GRÁFICO**

# SENSOR ULTRASSÔNICO

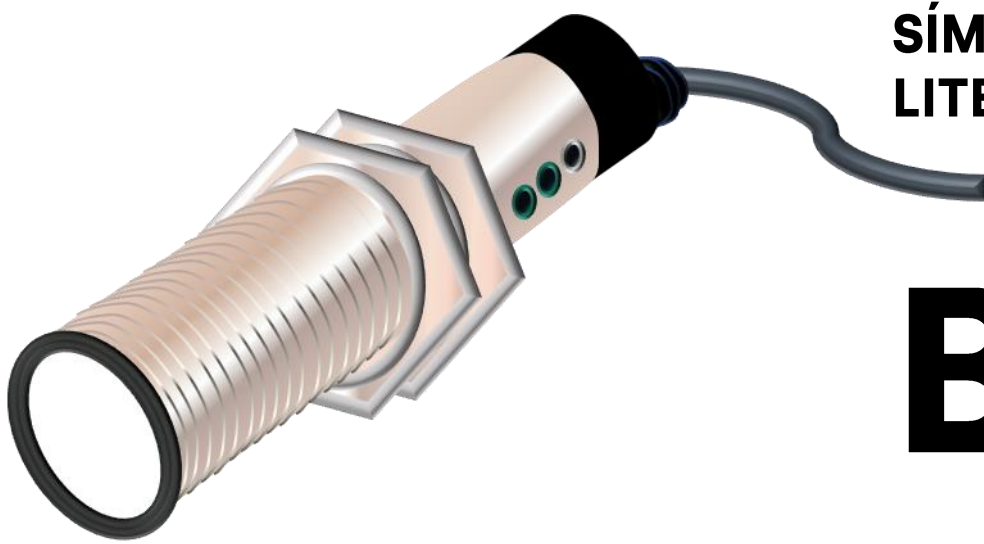

**SÍMBOLO  
LITERAL**

**B**

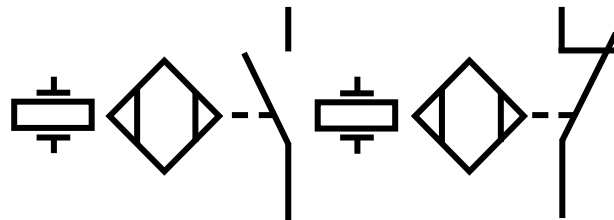
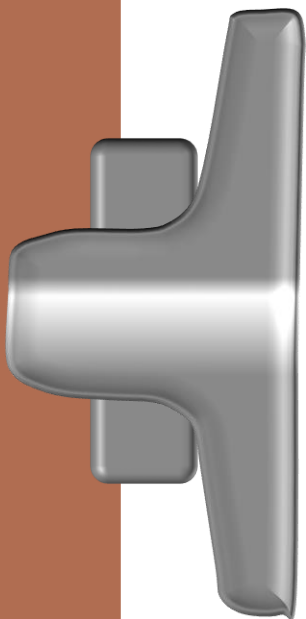

**SÍMBOLO  
GRÁFICO**