

**CIRCUITOS LKT OU LKC OU
TEOREMA DA
SUPERPOSIÇÃO**
Lista de Exercícios

Nos circuitos a baixo encontre a potencia das fontes de tensão e corrente utilizando LKT, ou LKC ou o Teorema da Superposição(TS), Conforme indicado no quadro ao lado do circuito.

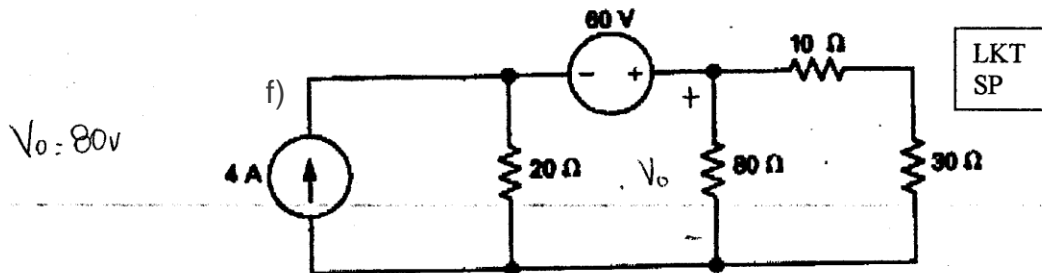
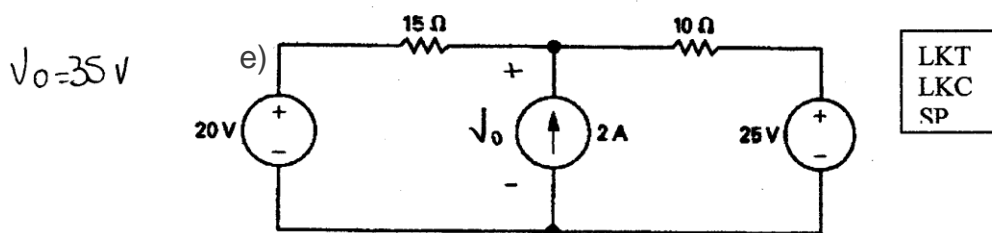
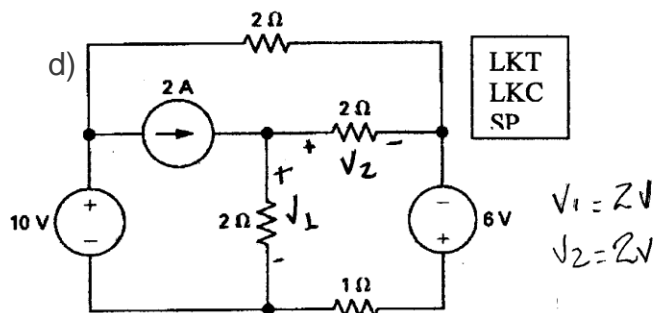
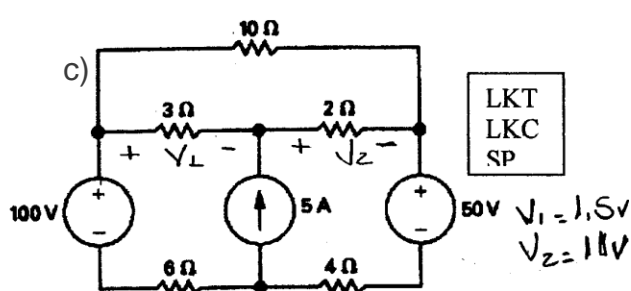
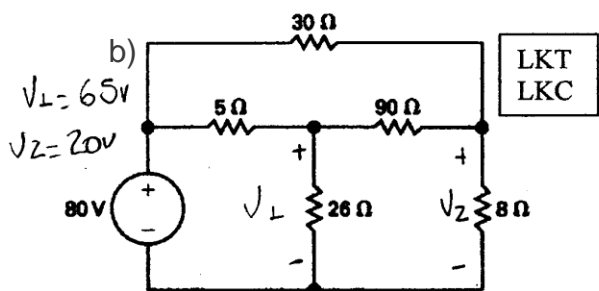
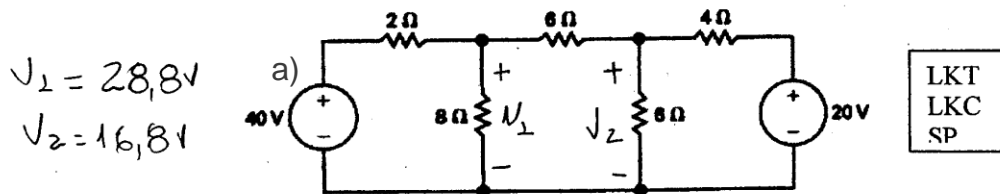

ELETRICIDADE BÁSICA EM REGIME DE CORRENTE CONTINUA - ELETROTÉCNICA

$V_L = 96V$
 $V_Z = 60V$

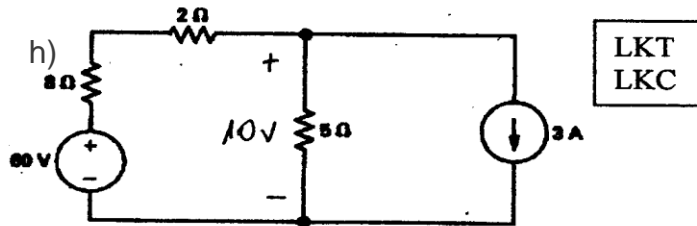
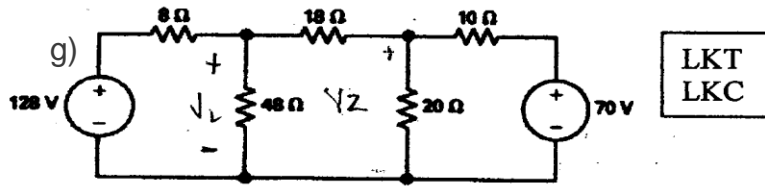

$V_L = 62,857V$
 $V_Z = 54,286V$
 $V_3 = 157,143V$

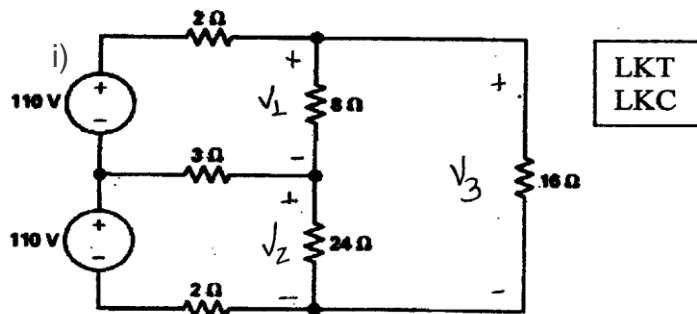

$V_L = 25V$
 $V_Z = 90V$

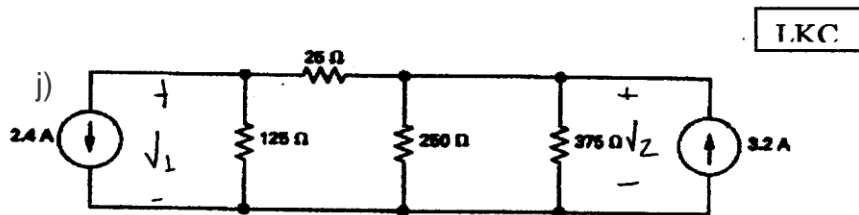

$V_L = V_Z = 111V$

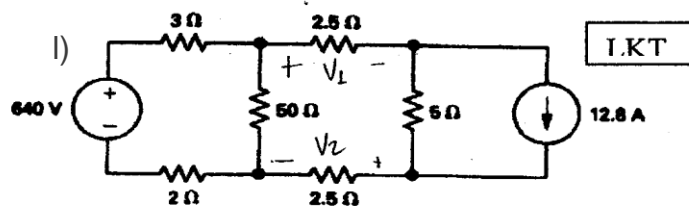

$V_1 = 80V$
 $V_2 = 20V$

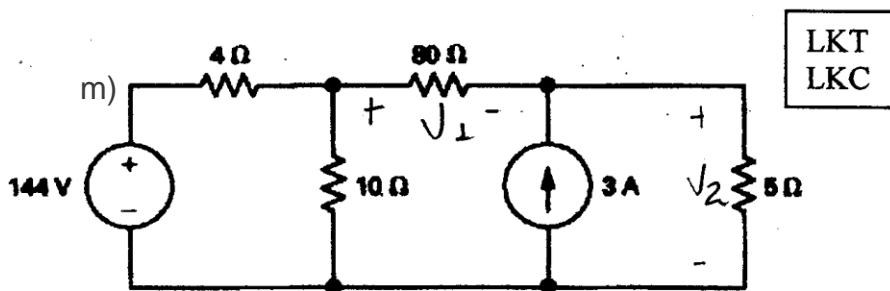

$V_1 = 115V$
 $V_2 = 172V$
 $V_3 = 287V$

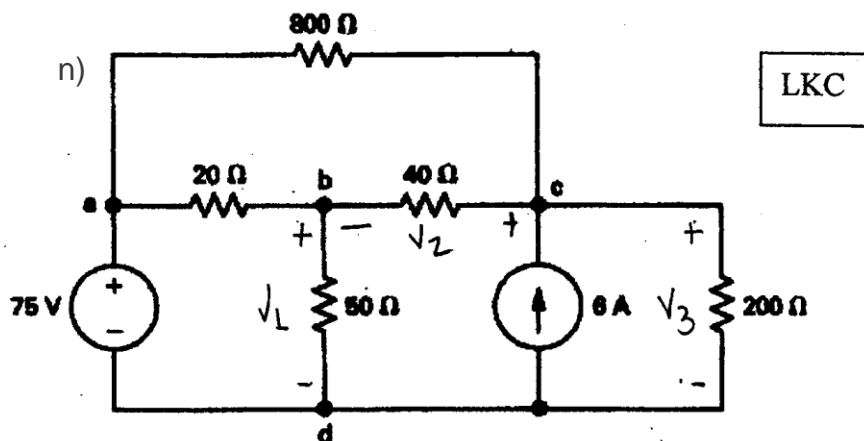

$V_1 = 30V$
 $V_2 = 2V$
 $V_3 = 48V$

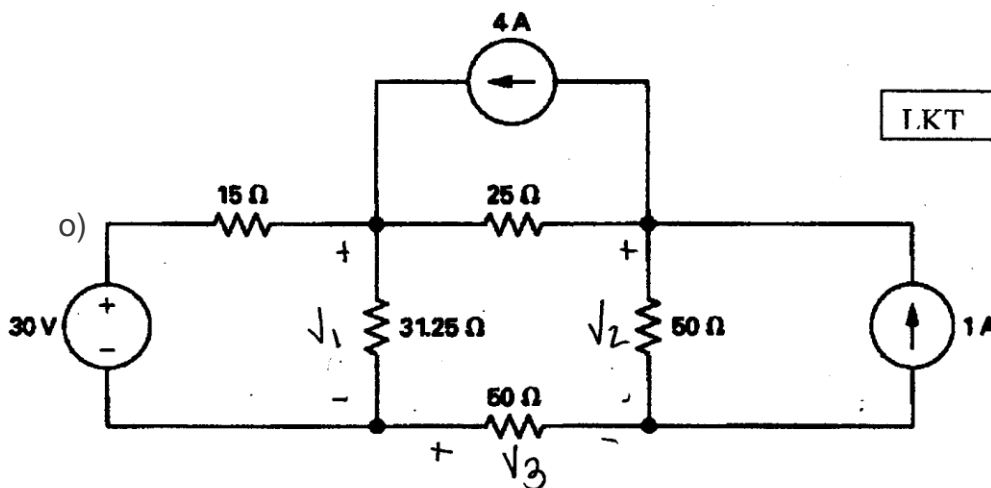

$V_L = 00V$
 $V_Z = 60V$

LKT
LKC

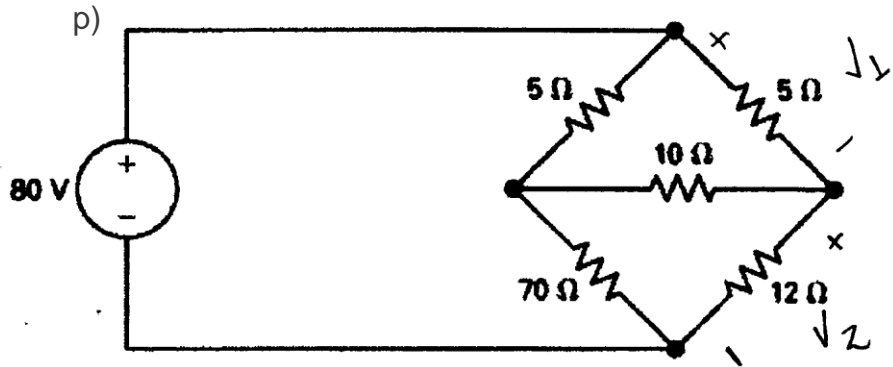

LKC

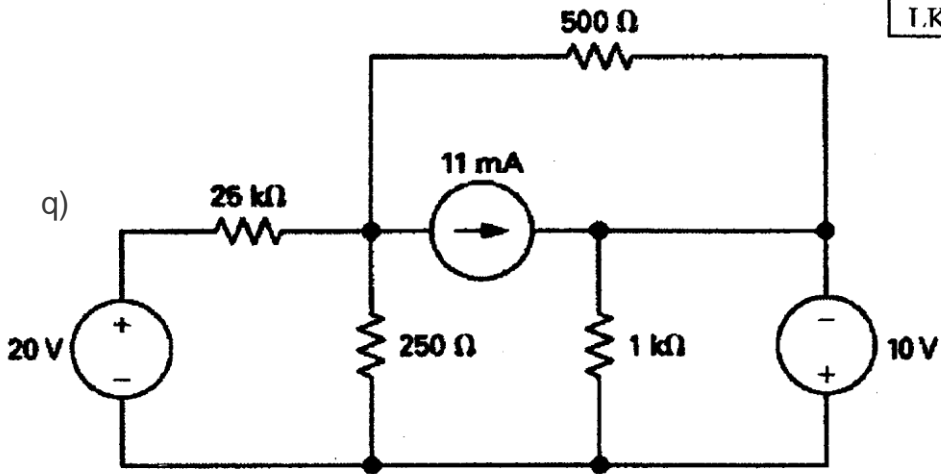

LKT e LKC
Escrever apenas as equações.

