

Atividade 4

5) Represente em três vistas, no espaço ao lado, as peças a seguir:

23

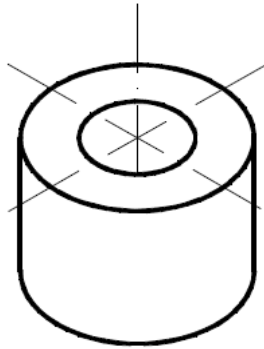

24

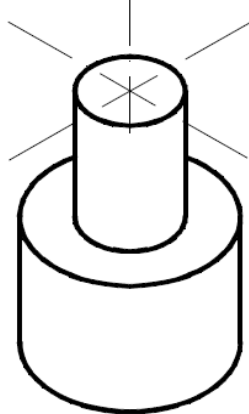

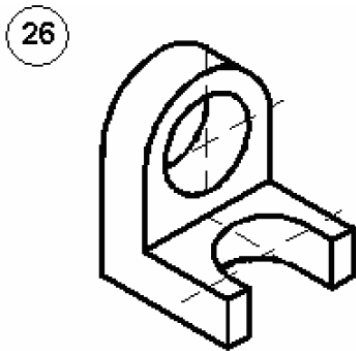
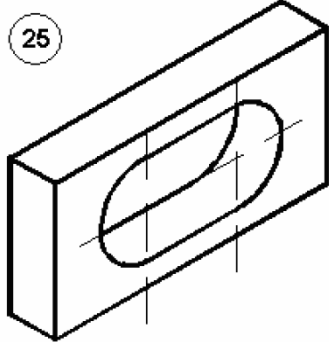

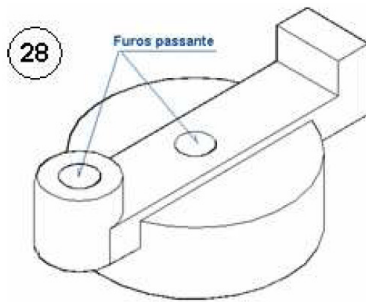
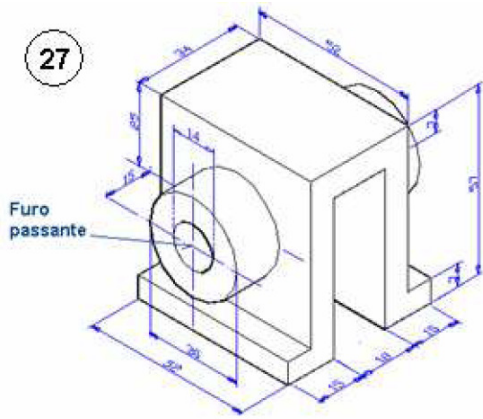

6) Dada duas vistas de uma peça construa a terceira no espaço pontilhado e faça também a sua perspectiva isométrica, usando os segmentos já traçados ao lado das respectivas vistas.

a

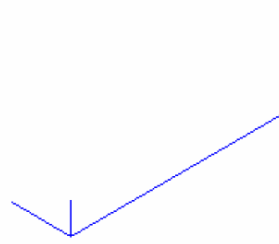
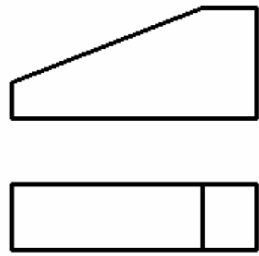

b

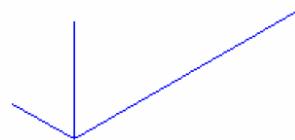

c

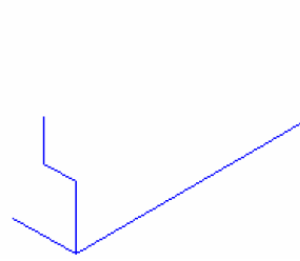
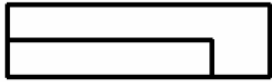
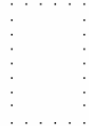

d

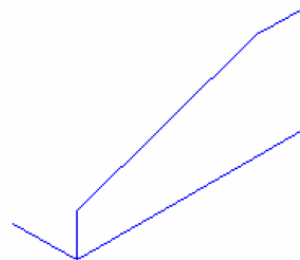
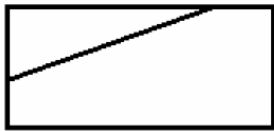

e

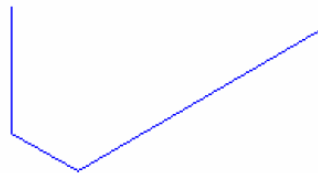
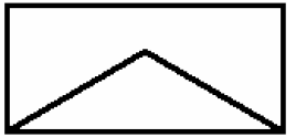

f

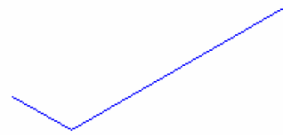

g

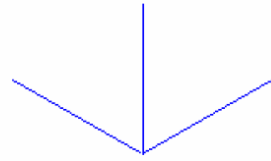
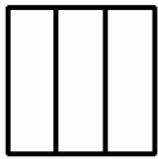
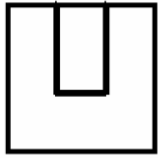

h

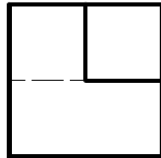
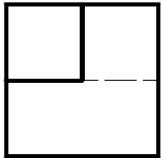

i

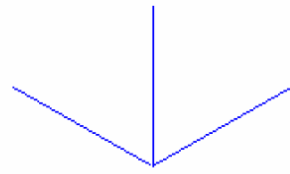
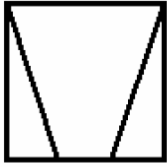

j

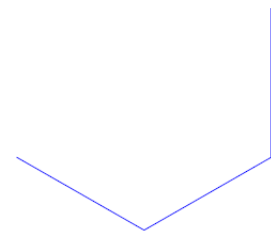
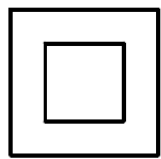
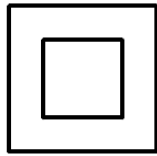

k

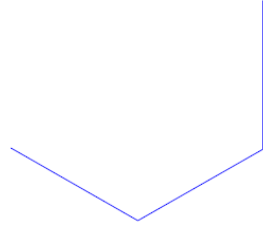
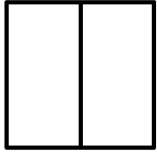
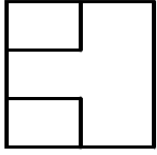

l

