

3_1Atividade3_13.1_Identifique e numere as projeções correspondentes a cada peça apresentada em perspectiva

a)

 <p>1</p>		
 <p>2</p>		
 <p>3</p>		
 <p>4</p>		
 <p>5</p>		
 <p>6</p>		

b)

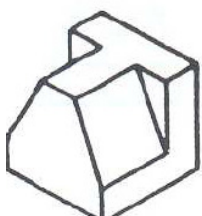
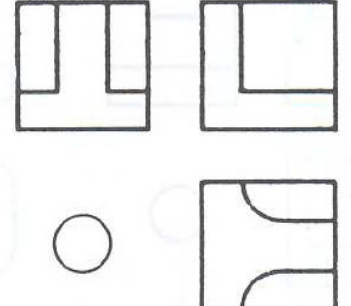
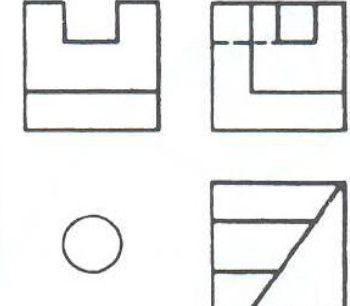
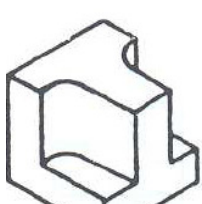
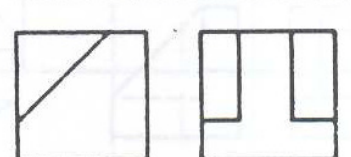
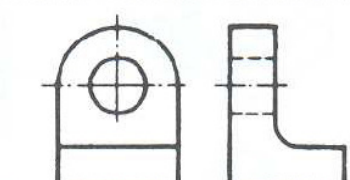
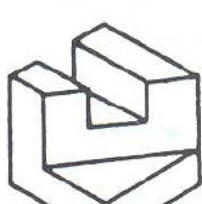
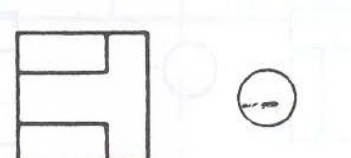
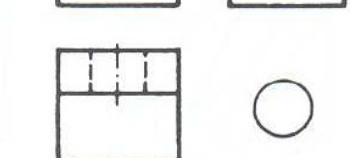
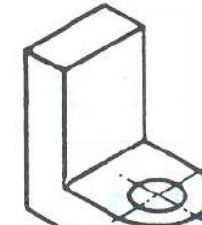
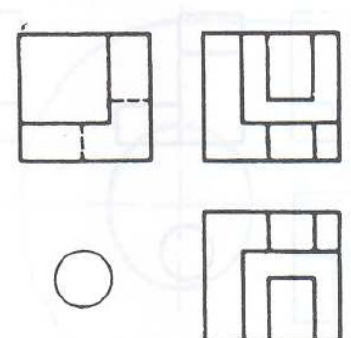
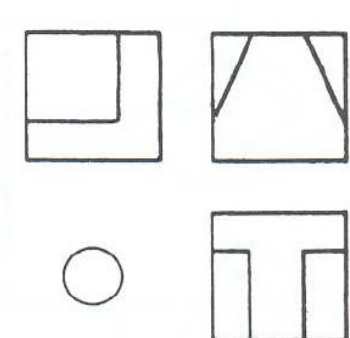
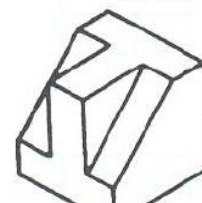
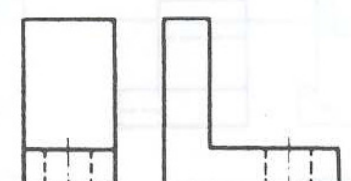
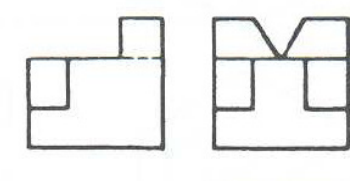
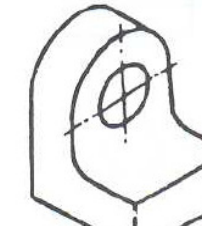
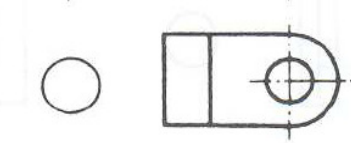
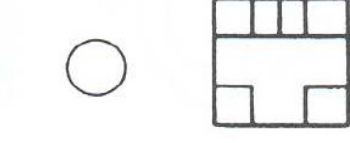
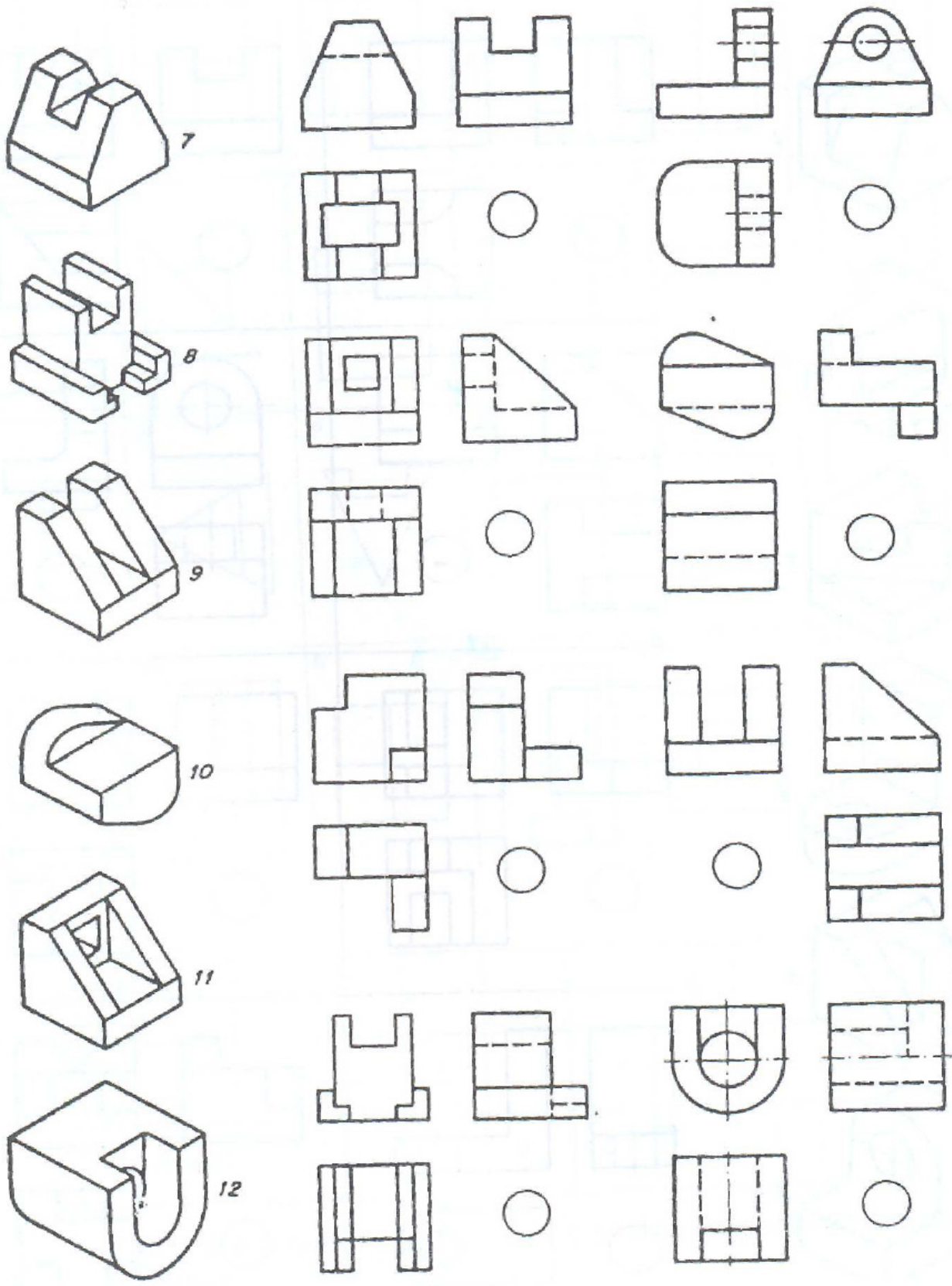

4) Desenhe as três vistas das peças abaixo em folha A4 com legenda em caligrafia técnica.
O tamanho das vistas devem ser obtidos diretamente das perspectivas.

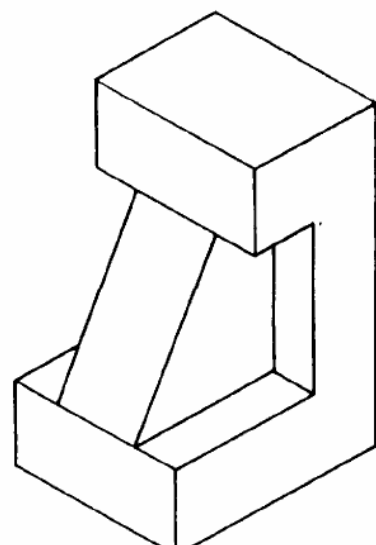
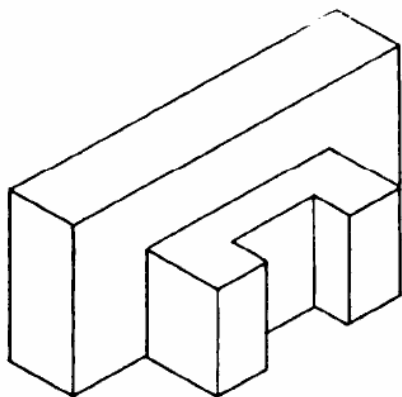
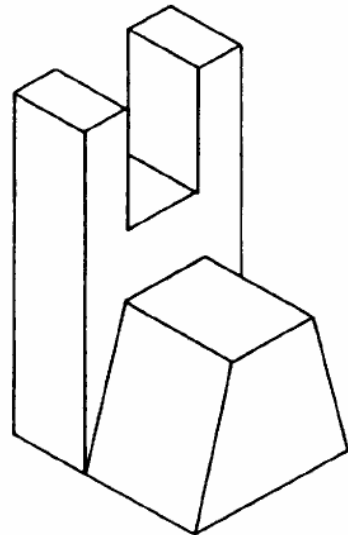
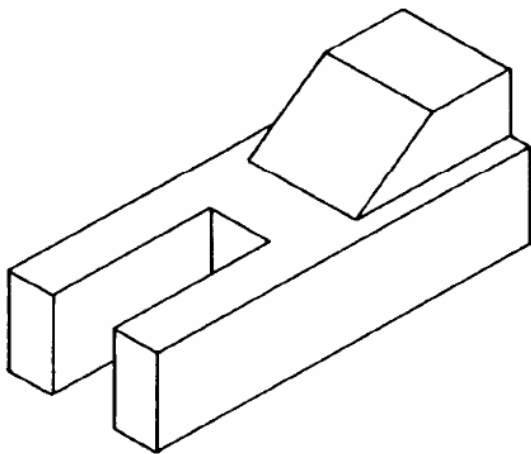

5- Complete o quadro abaixo com o número das respectivas vistas falantes.

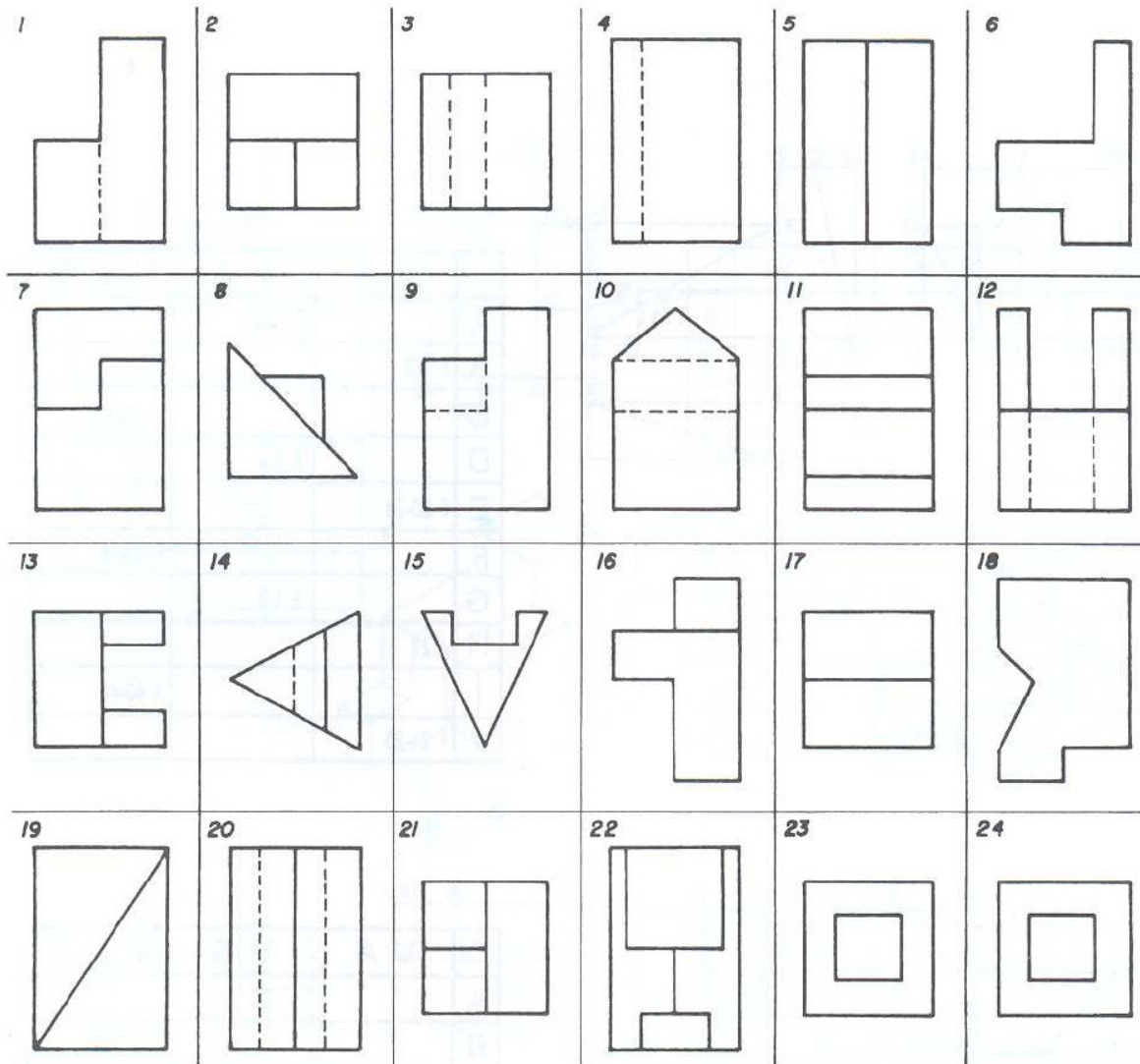

Vista de frente	1					6		
Vista superior		2	3					
Vista lateral				4	5		7	8