

**Atividade 2**

**Exercícios:**

1) Dado à perspectiva isométrica da peça, faça a mão livre à respectiva representação ao lado em forma de vistas: frontal; superior e lateral esquerda. Respeite as proporções de cada peça de acordo com os exemplos.

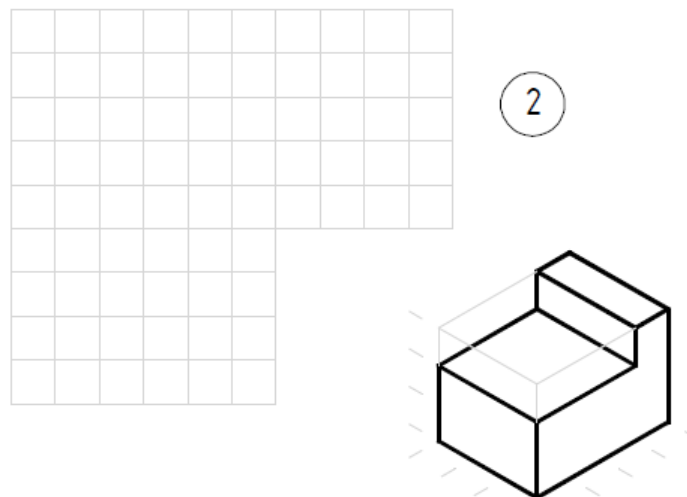

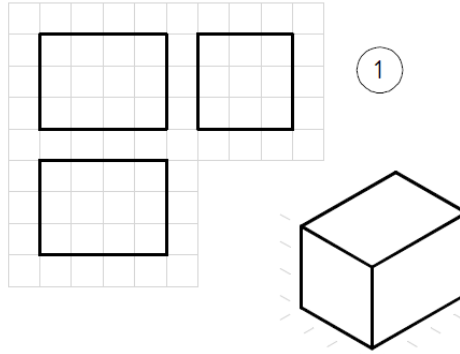
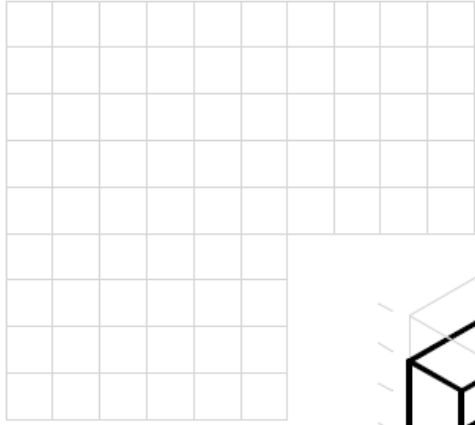

3

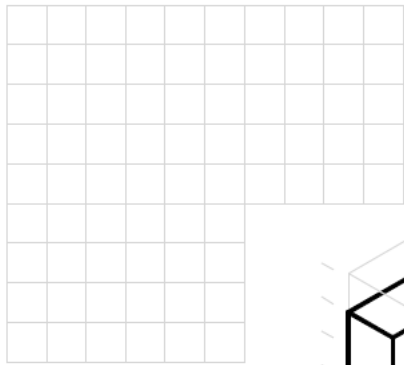
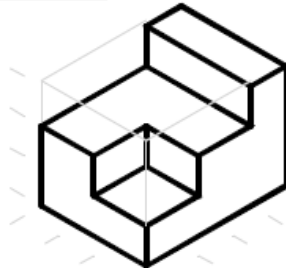

4

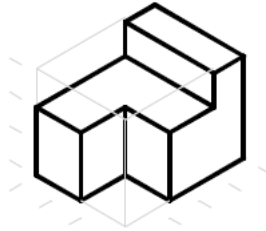

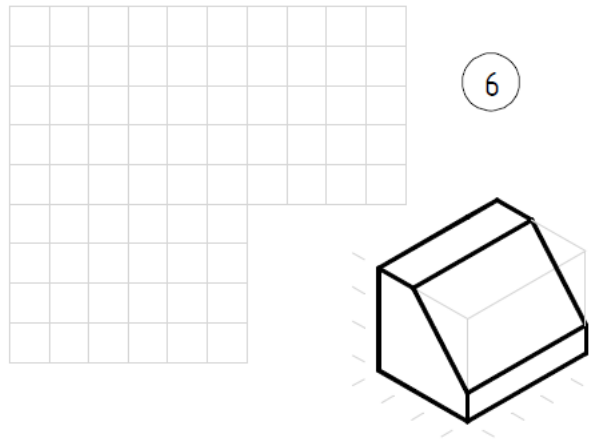
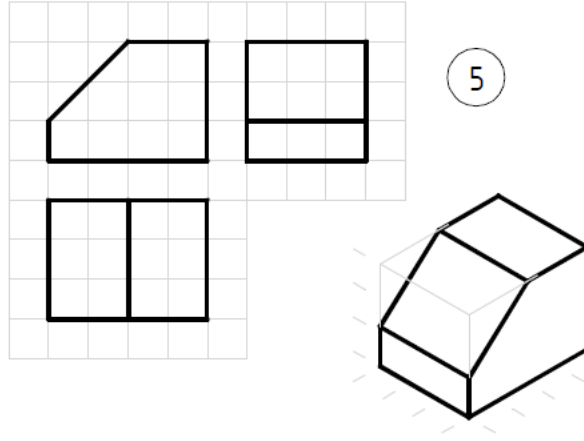

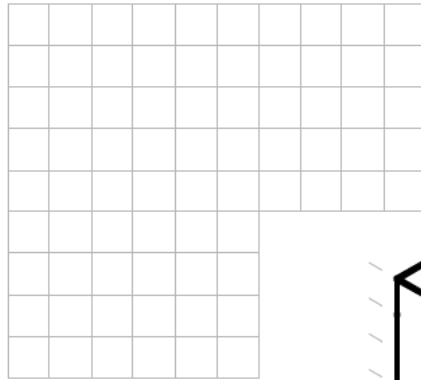

7

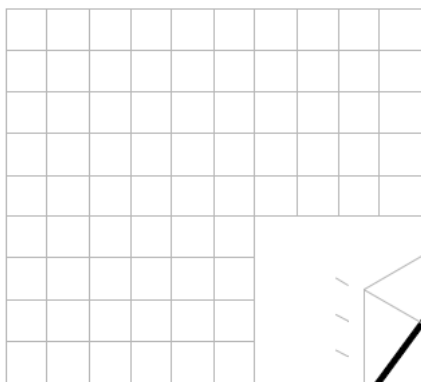
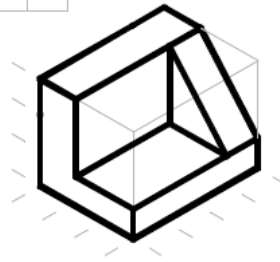

8

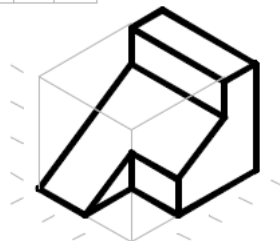

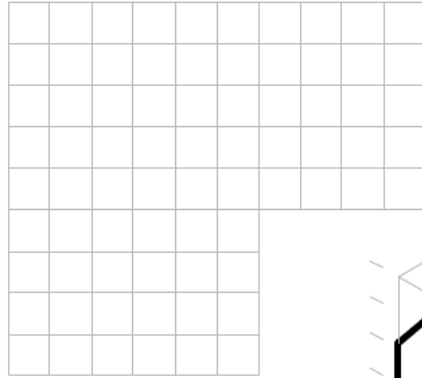

9

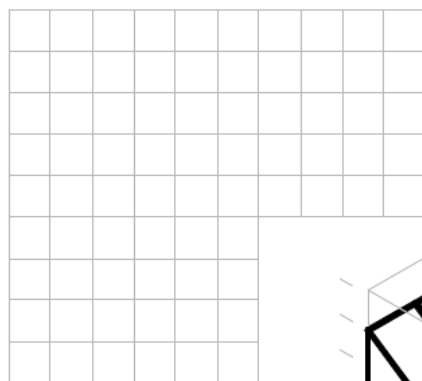
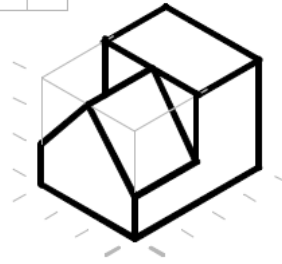

10

